

Frameless Tub / Shower Enclosure

INSTALLATION INSTRUCTIONS

Model Numbers

Tub Enclosures 140F	Shower Enclosures 150F, 151F
------------------------	---------------------------------

To install your shower enclosure, you will need the following:

- level
- 3/32", 1/8" and 3/16" drill bits
- phillips screwdriver
- sealant

GLAZED
includes glass

KD
does not
include glass

NOTE: K.D. units include all metal parts and hardware, but do not include glass.

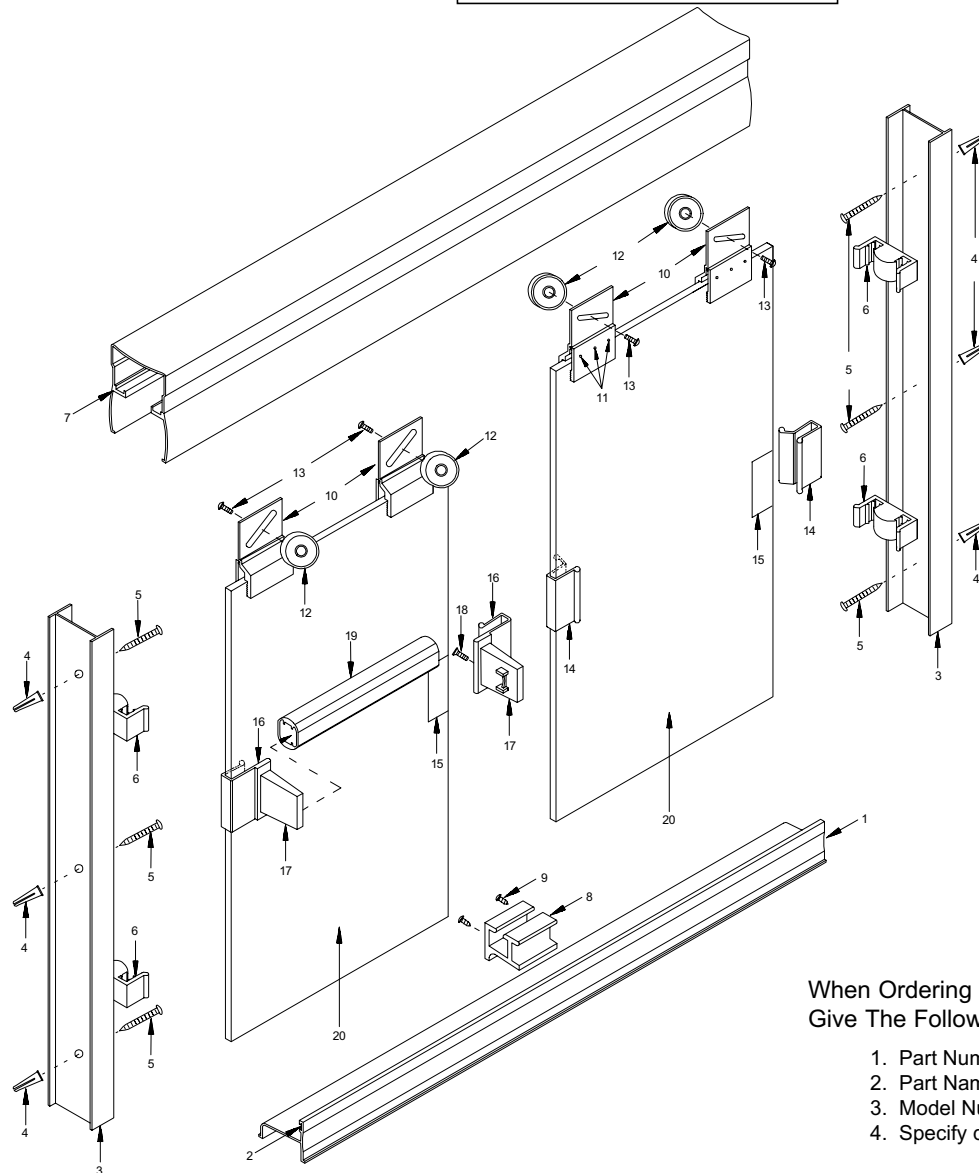

When Ordering Repair Parts, Please Give The Following Information:

1. Part Number
2. Part Name
3. Model Number
4. Specify design, if any

Description	Qty.	Part #	
1. Track	1	CFM-320B	
2. Track silencer	1	V622	
3. Wall jamba or Wall jamba	2	CFM-27	
	2	CFM-19	
4. Wall anchors	6	NO240	
5. #8 x 1" TH SMS	6	300	
6. Jamb guides	4	2406	
7. Header	1	CFM-25	
8. Track guide	1	1412	
9. #6 x 3/8" PH SMS	2	205	
10. Roller brackets	4	CFM-20/21	
11. #6-32 x 1/2" PH MS	12		
12. Rollers	4	NO260	
13. #8-32 x 3/8" PH MS	4	302	
14. Inside door handles	2	CFM-22	
15. Rubber pads for handles	4		
16. Towel bar bracket holders	2	CFM-23	
17. Towel bar brackets	2	T-19-2239	
18. #8-32 x 3/8" FH MS	2		
19. Towel bar	1	CFM-82	
20. Glass panels	2		
21. #8 x 1 1/2" TH SMS	6	130	

Step 1

MODELS 140F, 150F, 151F

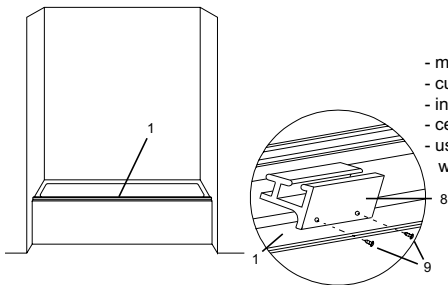

- measure the wall to wall opening on tub rim.
- cut track (1) 3/8" less than opening width.
- insert track silencer (2) into track.
- center track guide (8) on track.
- using a 3/32" drill bit, drill holes and secure track guide to track with two #6 x 3/8" flat head machine screws (9).

Step 2

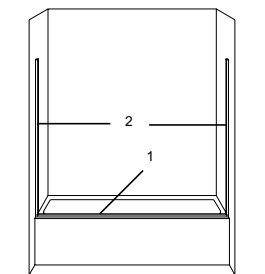

- place track (1) on center of tub rim.
- set wall jambs (3) firmly in track (1) next to wall.
- plumb and mark installation holes on wall.
- Note:** it is important that the wall jambs are plumb.
- if track does not fit flat, a slight bending of the track might be needed.

Step 3

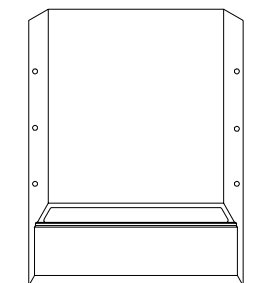

- remove all parts.
- for ceramic tile installation, use a 3/16" masonry bit for drilling installation holes and install plastic wall anchors (4).
- for fiberglass walls, use a 3/32" drill bit for drilling installation holes.

Step 4

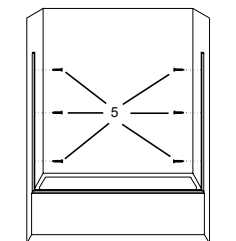

- apply a continuous bead of sealant to the bottom legs of track. A build up of sealant on each end of the tub rim (where track is to fit) will be needed.
- replace track in previous location.
- replace jambs (2) and secure to wall with six #8 x 1" truss head sheet metal screws (5).
- remove double face tape from jamb guides (6) and place in wall channels.

Step 5

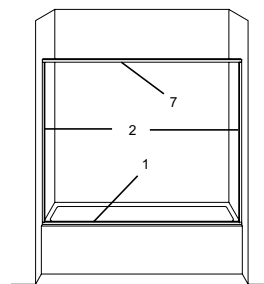

- measure the wall to wall opening above the wall jambs.
- cut header (6) 1/16" less than opening
- place header over jambs

Step 6

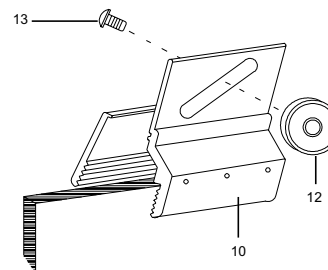

- assemble bearing brackets with four #6-32 x 1/2" PH MS (11).
- before attaching assembled bearing brackets to glass, place a bead of silicone into open part of brackets.
- bearing brackets are mounted in opposite directions to create interior and exterior panels
- attach bearing brackets (10) to panels.
- Note:** make sure screws are tightened securely to provide proper holding power.
- attach rollers (12) to brackets (10) on top of doors with four #8-32 x 3/8" pan head machine screws (13).

Step 7

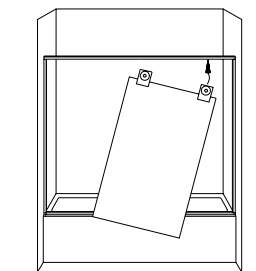

- lift inside door into header, placing rollers down in track.
- fit panel to wall by adjusting rollers.
- Note:** Inside panel must be placed next to the wall with the shower head. Adjust rollers so door contacts both plastic guides evenly.
- use the same procedure for outside door.

Step 8

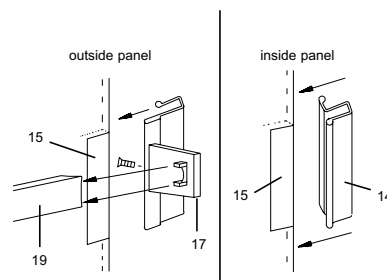

For Outside door

- attach towel bar brackets (17) to towel bar bracket holders (16) with two #8 x 3/8" flat head machine screws (18).
- press the towel bar bracket holder and rubber pad (15) over glass.
- insert towel bar (19) into towel bar bracket, then press other towel bar bracket holder and rubber pad onto glass panel locking towel bar into place.

For Inside Door

- press inside door handles (14) and rubber pads over glass

Step 9

- seal inside and outside of unit at any point unit meets wall or curb.